

# ABS-Lock<sup>®</sup> X-SR-HD

LX-SR-HD-XXX



MoA 116-08



## Werkzeuge | Tools



17



16



## Sicherheitshinweise | Safety instructions



- DE** Montageanleitung beachten (1) und Sicherheitshinweise beachten (2).
- EN** Comply with the installation manual (1) and Comply with the safety instructions (2).
- FR** Respecter la notice de montage (1) and Respecter les consignes de sécurité (2).
- NL** Montagehandleiding in acht nemen (1) and Veiligheidsinstructies in acht nemen (2).
- BGR** Спазвайте инструкциите за монтаж (1) and Спазвайте инструкциите за безопасност (2).
- DK** Følg monteringsvejledningen (1) and Følg sikkerhedshenvisningerne (2).
- ET** Järgige paigaldusjuhendit (1) ja ohutusjuhiseid (2).
- FI** Noudata asennusohjeita (1) and Noudata turvallisuusohjeita (2).
- IT** Rispettare le istruzioni di montaggio (1) and Rispettare le istruzioni di sicurezza (2).
- PL** Przestrzegać zaleceń instrukcji montażu (1) and Przestrzegać zasad bezpieczeństwa (2).
- SK** Dodržujte návod na montáž (1) and Dodržujte bezpečnostné pokyny (2).
- SL** Sledite navodilom za namestitve (1) and Sledite varnostnim navodilom (2).
- ES** Observar las instrucciones de montaje (1) and Observar las indicaciones de seguridad (2).
- CS** Dodržujte návod k montáži (1) and Dodržujte bezpečnostní pokyny (2).
- HU** Vegye figyelembe az összeszerelési útmutatót (1) and Vegye figyelembe a biztonsági utasításokat (2).

Für eine ordnungsgemäße Montage ist eine Dokumentation des Einbaus zwingend erforderlich!  
For a proper installation, a complete documentation of assembly is absolutely necessary.

## Kontakte | Contact persons

**Vertrieb & Technische Beratung**  
Sales & Technical Support

+49 (0) 28 32 - 972 81 - 0  
vertrieb@absturzicherung.de

**Schulung**  
Training

+49 (0) 28 32 - 972 81 - 148  
schulung@absturzicherung.de

**Montagevorbereitung**  
Assembly

+49 (0) 28 32 - 972 81 - 260  
service@absturzicherung.de

## Mustertypenschild | Sample label

[ABS]

**ABS SAFETY GMBH** 3

Kevelaer, Germany  
info@absturzicherung.de  
www.absturzicherung.de

---

**Mustertypenschild /**  
**Sample only**

**Chargennummer /**  
**Batch number**

---

6	Normen / Standards	-
7	Max. Nutzer gleichzeitig (DIN EN 795:2012) Max. No. of simultaneous users	-
11	Modellnummer / Model number	-
-	-	-
-	-	-
-	-	-

8	CE	9	[ABS]	10	Z-14.9-668
0158			Z-14.9-668		DEKRA

# Montageschritte dokumentieren

Document assembly step



**Dokumentation  
ist Pflicht!**

Documentation is compulsory!

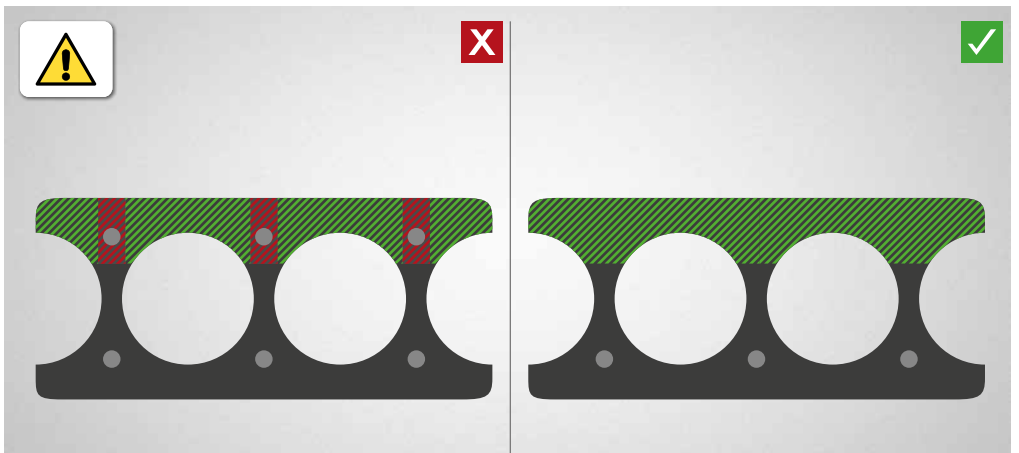
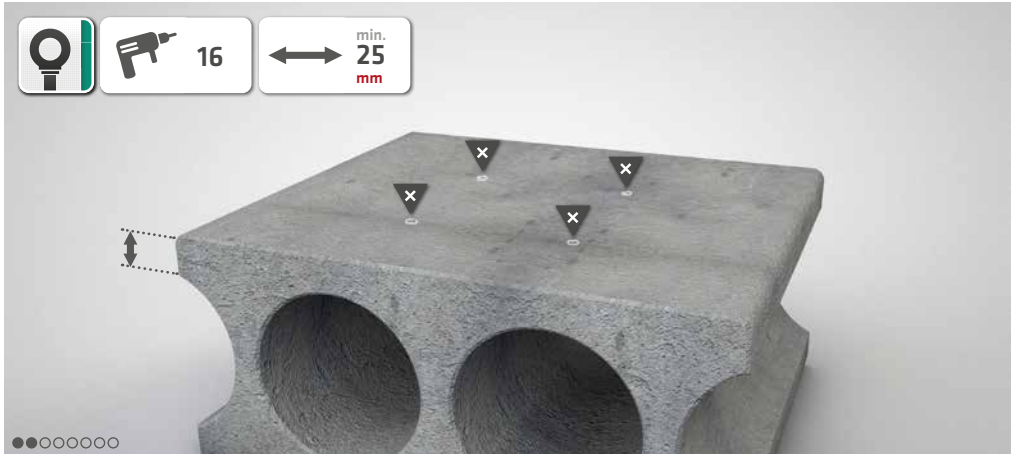
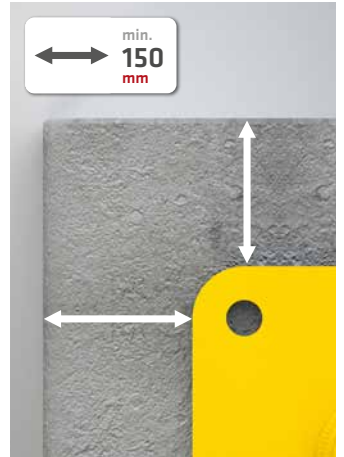

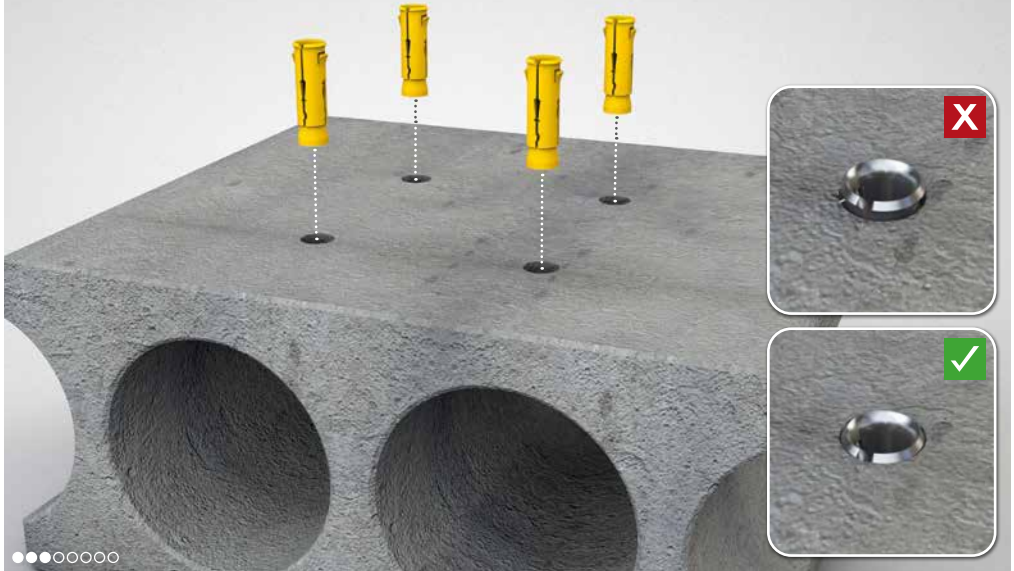



• Nm | 17  
20 Nm

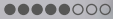
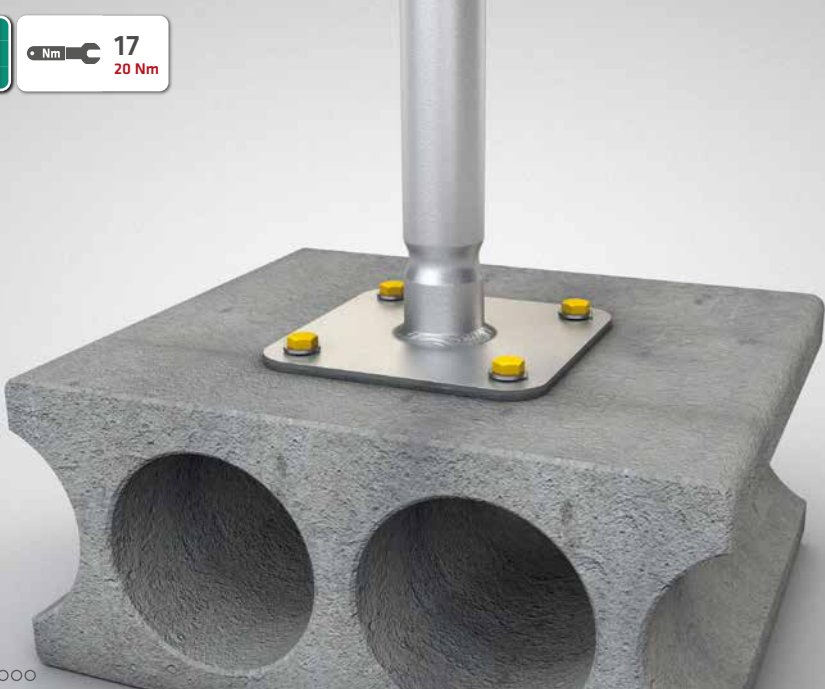

• Nm | 50 Nm

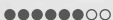



# ALWAYS ON TOP!

## ABS Safety GmbH

Gewerbering 3  
D-47623 Kevelaer  
Germany

Tel.: +49 28 32 972 81 - 0  
Fax: +49 28 32 972 81 - 285

[info@absturzsicung.de](mailto:info@absturzsicung.de)

 [www.absturzsicung.de](http://www.absturzsicung.de)

 [.de/en](http://.de/en)

 [.de/fr](http://.de/fr)

 [.de/nl](http://.de/nl)

RS 15. März 2021



[instagram.com/abssafety](https://www.instagram.com/abssafety)



[youtube.com/abssafetygmbh](https://www.youtube.com/abssafetygmbh)



[facebook.com/ABS.Safety](https://www.facebook.com/ABS.Safety)