

ABS-Lock[®] III-SEITL-65

L3-SEITL-XXX-65

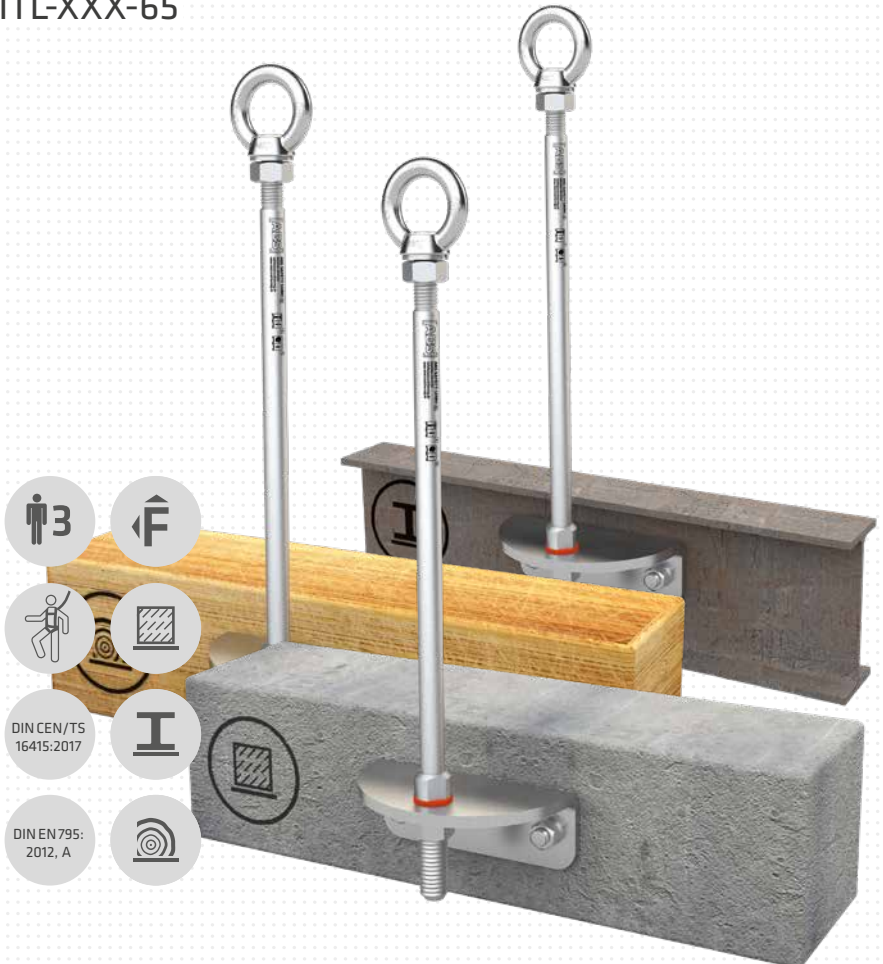

Werkzeuge | Tools



13, 14



19, 24



19, 24

Sicherheitshinweise | Safety instructions



- DE** Die Anweisungen der Montageanleitung (1) und Sicherheitshinweise (2) sind strikt einzuhalten.
- EN** The information contained in the assembly instructions (1) and safety instructions (2) must be strictly observed.
- NL** De aanwijzingen in de montagehandleiding (1) en de veiligheidsvoorschriften (2) moeten strikt worden nageleefd.
- ES** Respete estrictamente las instrucciones del manual de montaje (1) y las indicaciones de seguridad (2).
- IT** È assolutamente necessario attenersi alle istruzioni di montaggio (1) e alle norme di sicurezza (2).
- FR** Les instructions de la notice de montage (1) et les consignes de sécurité (2) doivent être formellement respectées.
- PL** Należy ściśle przestrzegać instrukcji montażu (1) i wskazań bezpieczeństwa (2).
- DK** Montagevejledningens (1) anvisninger som også sikkerhedshenvisningerne (2) skal overholdes.
- CZ** Je nutné striktně dodržovat instrukce obsažené v montážním návodu (1) a v bezpečnostních pokynech (2).
- GR** Πρέπει να τηρούνται αυστηρά οι οδηγίες του χειριδίου συναρμολόγησης (1) και των υποδείξεων ασφαλείας (2).
- SK** Dôsledne dodržiavajte pokyny montážneho návodu (1) a bezpečnostné pokyny (2).
- TR** Montaj kılavuzunun (1) ve güvenliik uyarılarının talimatlarına (2) kesinlikle uyulmalıdır.
- NO** Det er svært viktig at instruksjonene i monteringshåndboken (1) og sikkerhetsheftet (2) følges.
- RUS** Необходимо строго соблюдать требования руководства по монтажу (1) и инструкции по безопасности (2).
- RO** Indicațiile din instrucțiunile de montare (1) și din broșura cu indicații de siguranță (2) trebuie respectate cu strictețe.
- FI** Asennusohjeen (1) ja turvaohjevhikosen (2) ohjeita on ehdottomasti noudatettava.
- SE** Anvisningarna till monteringsanvisningen (1) och säkerhetsmanualen (2) måste iakttas under alla omständigheter.
- HI** इंस्ट्रक्शन के निर्देशों (1) और सुरक्षा निर्देश मैनुअल (2) में दिये गये निर्देशों का सख्ती से अनुसरण किया जाना चाहिए।
- ZH** 必须严格遵守装配说明书 (1) 和安全须知单 (2) 中的指示。
- SQ** Jepib alntaraz baltelimebt wawwde fi zililil lrlrlrl (1) wktlil lrlrlrl (2) bmttlil lrlrlrl

Kontakte | Contact persons

Vertrieb & Technische Beratung
Sales & Technical Support
+49 (0) 28 32 - 972 81 - 0
vertrieb@absturzsicberung.de

Schulung
Training
+49 (0) 28 32 - 972 81 - 0
schulung@absturzsicberung.de

Montagevorbereitung
Assembly
+49 (0) 28 32 - 972 81 - 260
service@absturzsicberung.de

Mustertypenschild | Sample label

[ABS]

ABS SAFETY GMBH 3

Kevelaer, Germany
info@absturzsicberung.de
www.absturzsicberung.de

Mustertypenschild /
Sample only

Chargennummer /
Batch number

6	Normen / Standards	-
7	Max. Nutzer gleichzeitig (DIN EN 795:2012) Max. No. of simultaneous users	-
11	Modellnummer / Model number	-
-	-	-
-	-	-
-	-	-

8	CE
9	
10	



Montageschritte dokumentieren

Document assembly step



abs.lock-book.com



Holz / Stahl
Wood / Steel



Beton
Concrete

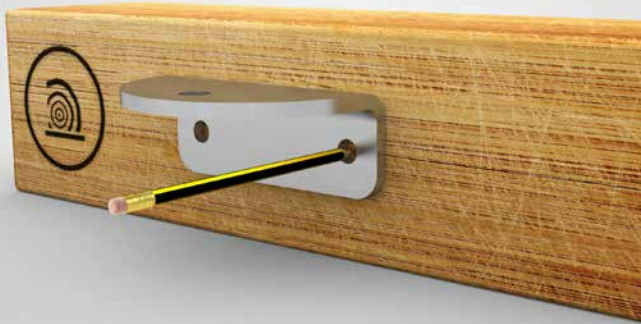

●○○○○○○○○

a min. 100 mm

b min. 120 mm

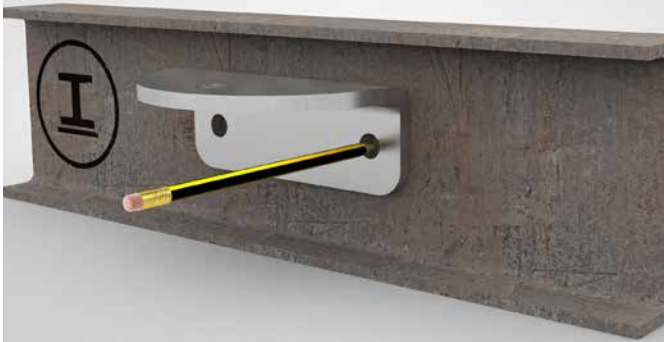
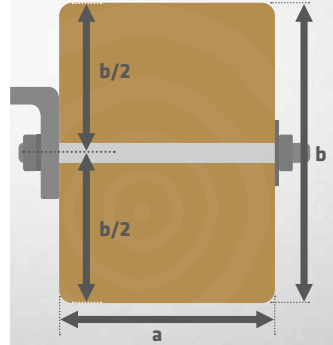

●○○○○○○○○

min. 5 mm

min. 20 mm

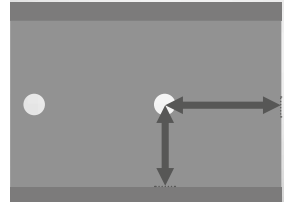

max. 55 mm

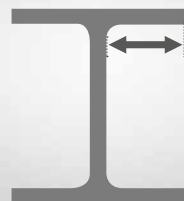



13

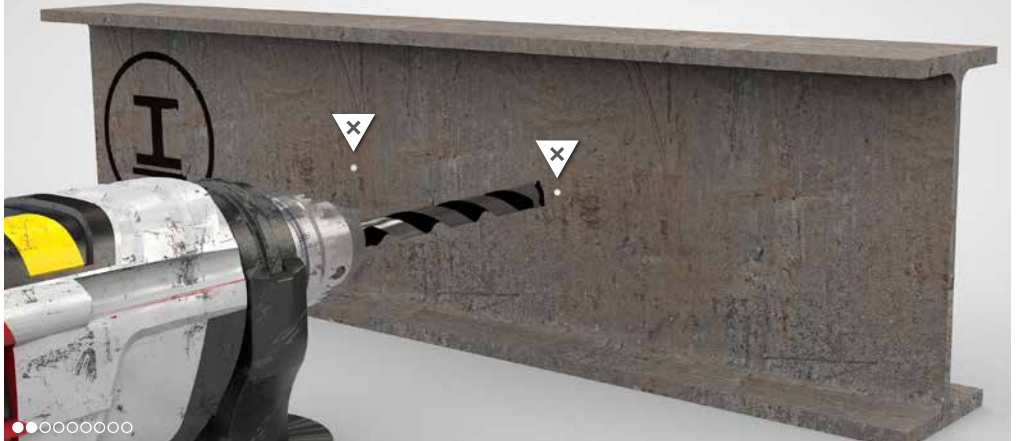

Optional

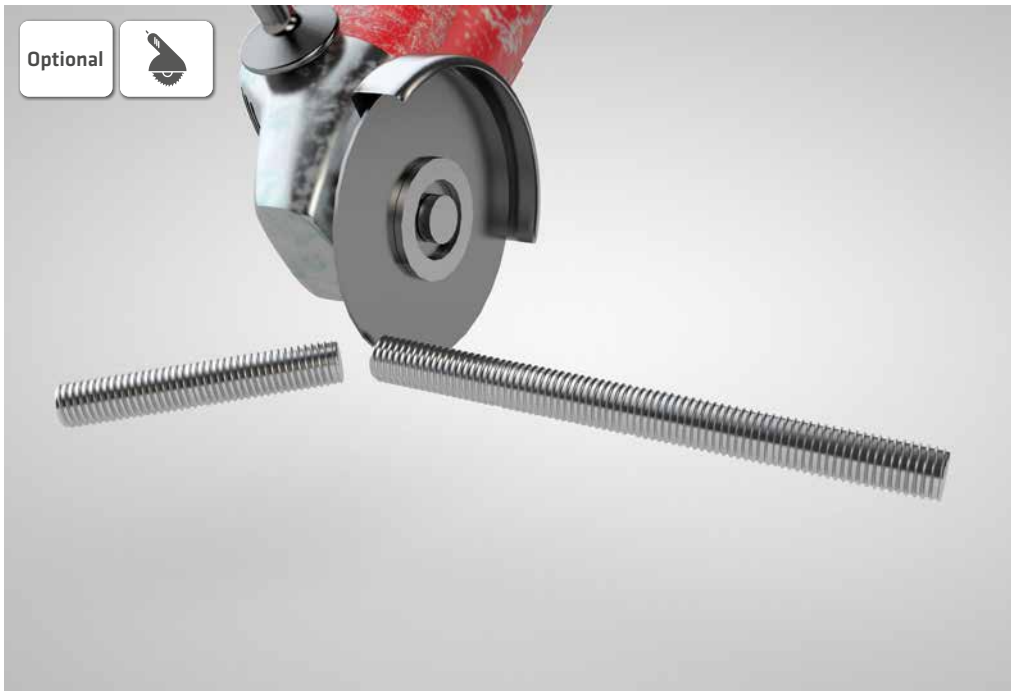

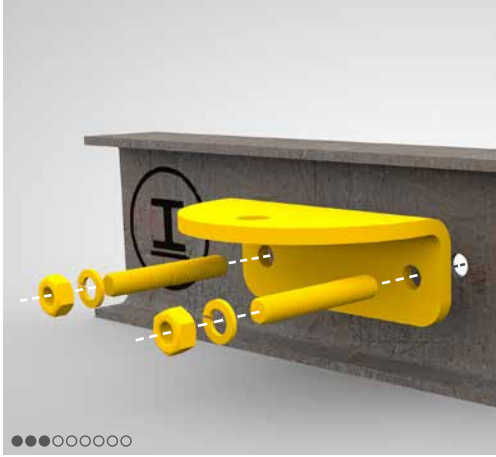





min.
55
mm



C 20/25

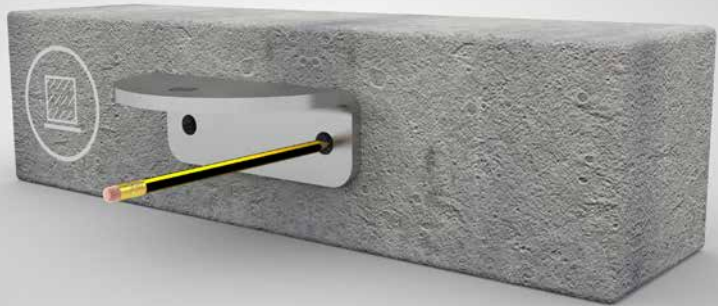

● ○ ○ ○ ○ ○ ○ ○



14

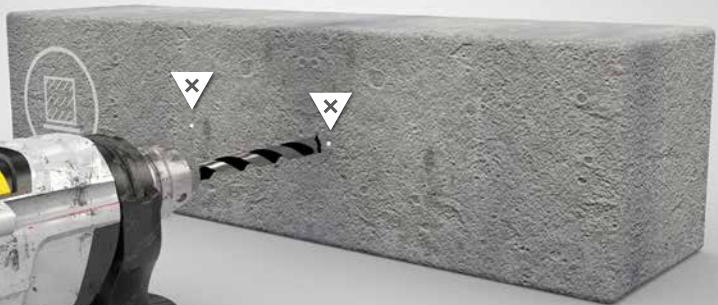
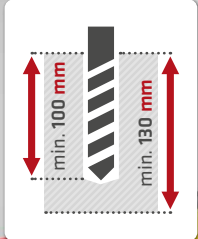

● ● ○ ○ ○ ○ ○ ○ ○ ○



4x



Verbundmörtel
Special Adhesive
WIT-VM-250 • MoA-134

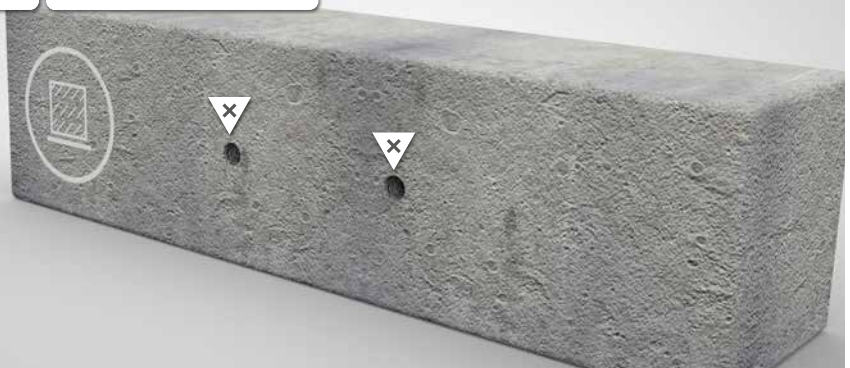

● ● ● ○ ○ ○ ○ ○ ○ ○ ○

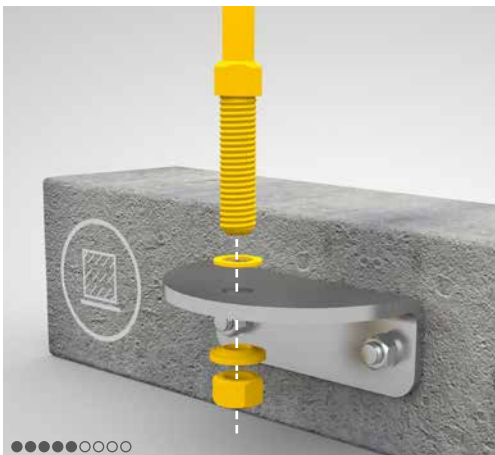



ALWAYS ON TOP!

ABS Safety GmbH

Gewerbering 3
D-47623 Kevelaer
Germany

Tel.: +49 (0) 28 32 - 972 81 - 0
Fax: +49 (0) 28 32 - 972 81 - 29

info@absturzsicherung.de

www.absturzsicherung.de
www.protection-anti-chute.fr
www.fall-arrest.eu

RS 7/6 Oktober 2020



[instagram.com/abssafety](https://www.instagram.com/abssafety)



[youtube.com/abssafetygmbh](https://www.youtube.com/abssafetygmbh)



[facebook.com/ABS.Safety](https://www.facebook.com/ABS.Safety)