



ABS-Lock[®] Falz V

PF-5-XX



MoA 052-17





Werkzeuge | Tools



Sicherheitshinweise | Safety instructions

- DE** Montageanleitung beachten (1) und Sicherheitshinweise beachten (2).
- EN** Comply with the installation manual (1) and Comply with the safety instructions (2).
- FR** Respecter la notice de montage (1) and Respecter les consignes de sécurité (2).
- NL** Montagehandleiding in acht nemen (1) and Veiligheidsinstructies in acht nemen (2).
- BGR** Спазвайте инструкциите за монтаж (1) and Спазвайте инструкциите за безопасност (2).
- DK** Følg monteringsvejledningen (1) and Følg sikkerhedshenvisningerne (2).
- ET** Järgige paigaldusjuhendit (1) ja ohutusjuhiseid (2).
- FI** Noudata asennusohjeita (1) and Noudata turvallisuusohjeita (2).
- IT** Rispettare le istruzioni di montaggio (1) and Rispettare le istruzioni di sicurezza (2).
- PL** Przestrzegać zaleceń instrukcji montażu (1) and Przestrzegać zasad bezpieczeństwa (2).
- SK** Dodržujte návod na montáž (1) and Dodržujte bezpečnostné pokyny (2).
- SL** Sledite navodilom za namestitve (1) and Sledite varnostnim navodilom (2).
- ES** Observar las instrucciones de montaje (1) and Observar las indicaciones de seguridad (2).
- CS** Dodržujte návod k montáži (1) and Dodržujte bezpečnostní pokyny (2).
- HU** Vegye figyelembe az összeszerelési útmutatót (1) and Vegye figyelembe a biztonsági utasításokat (2).

Für eine ordnungsgemäße Montage ist eine Dokumentation des Einbaus zwingend erforderlich!
For a proper installation, a complete documentation of assembly is absolutely necessary.

Kontakte | Contact persons

Vertrieb & Technische Beratung
Sales & Technical Support
+49 (0) 28 32 - 972 81 - 0
vertrieb@absturzversicherung.de

Schulung
Training
+49 (0) 28 32 - 972 81 - 148
schulung@absturzversicherung.de

Montagevorbereitung
Assembly
+49 (0) 28 32 - 972 81 - 260
service@absturzversicherung.de

Mustertypenschild | Sample label

	<p>ABS SAFETY GMBH 3 Kevelaer, Germany info@absturzversicherung.de www.absturzversicherung.de</p>	<div style="display: flex; justify-content: space-around;"> <div style="text-align: center;"> 1 </div> <div style="text-align: center;"> 2 </div> </div>
<p>Typ / Produktbezeichnung 4 Typ / Produktbezeichnung</p>		<p>Chargennummer / Batch number 5</p>
<p>6 Normen / Standards</p> <p>7 Max. Nutzer gleichzeitig Max. No. of simultaneous users</p> <p>11 Modellnummer / Model number</p> <p>14 150 kg</p> <p><input type="checkbox"/> -</p> <p><input type="checkbox"/> -</p>	<p><input type="checkbox"/> -</p> <p><input type="checkbox"/> -</p> <p><input type="checkbox"/> -</p> <p><input type="checkbox"/> -</p> <p><input type="checkbox"/> -</p> <p><input type="checkbox"/> -</p>	<div style="display: flex; justify-content: space-around;"> <div style="text-align: center;"> 8 </div> <div style="text-align: center;"> 9 </div> <div style="text-align: center;"> 10 </div> </div>

Montageschritte dokumentieren

Document assembly step



Dokumentation mit Bildern vervollständigen!
Complete your documentation using pictures!

**Dokumentation
ist Pflicht!**































Documentation is compulsory!



ABS-Lock® Falz V
Rundbördelfalz



ABS-Lock® Falz V
Stehfalz

				
Edelstahl Stainless steel	Aluminium Aluminium	Kupfer Copper	Stahl Steel	Titanzink Titanium zinc
 -	 0,7 mm  3	 -	 -	 -
 0,5 mm  3	 0,7 mm  1  0,8 mm  3	 0,55 mm  1	 0,5 mm  3	 0,5 mm  3
 0,5 mm  3	 0,7 mm  1  0,8 mm  3	 0,55 mm  1	 0,5 mm  1	 0,5 mm  3

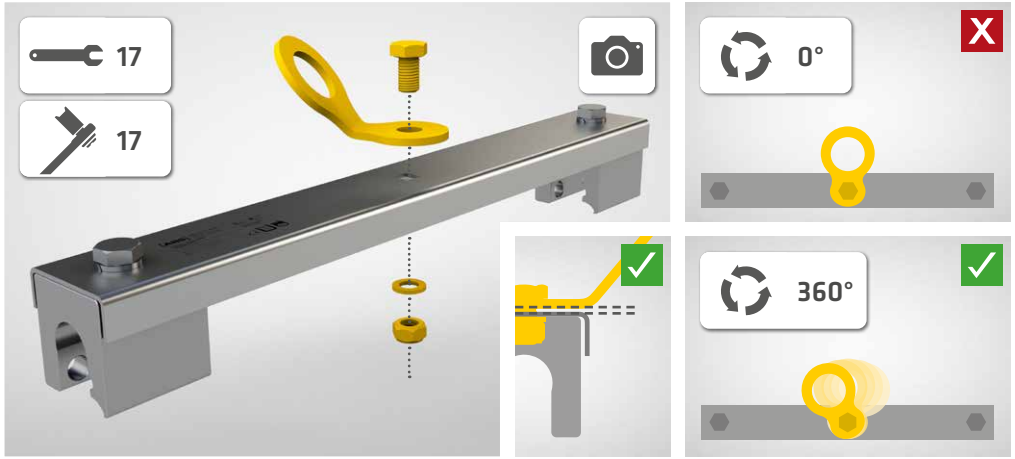



TX30 | 16 Nm



3 / 4



4 / 4



↔ 350
mm

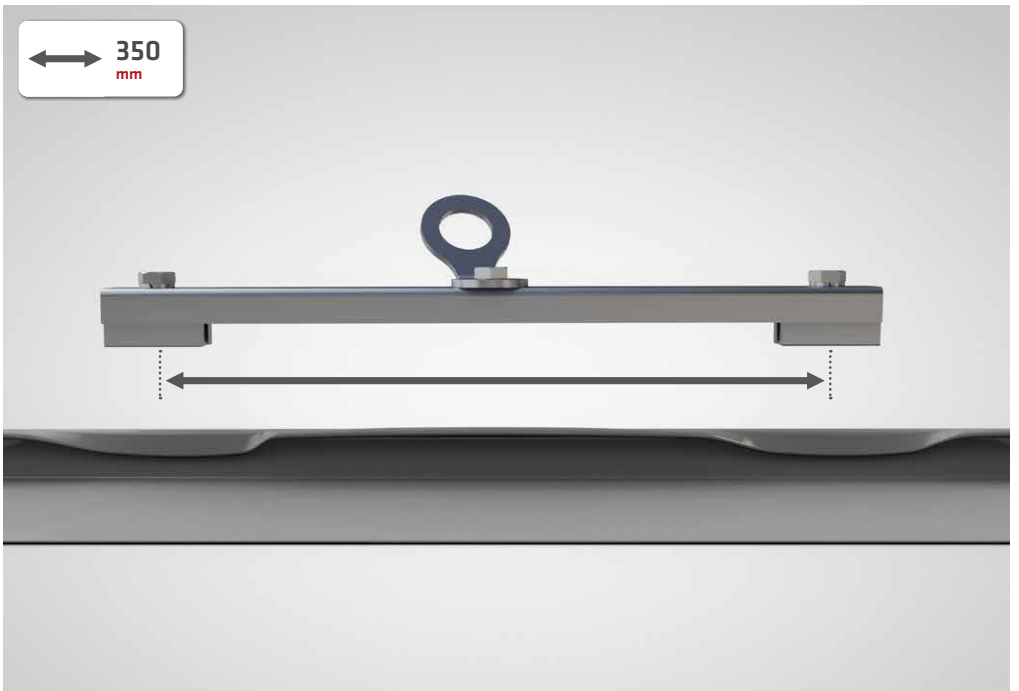

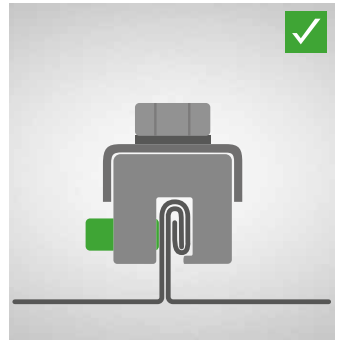
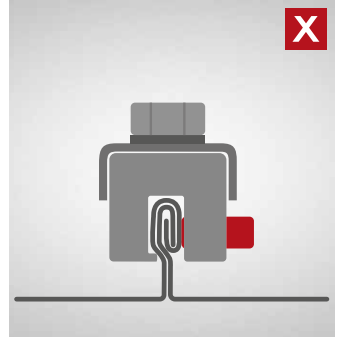
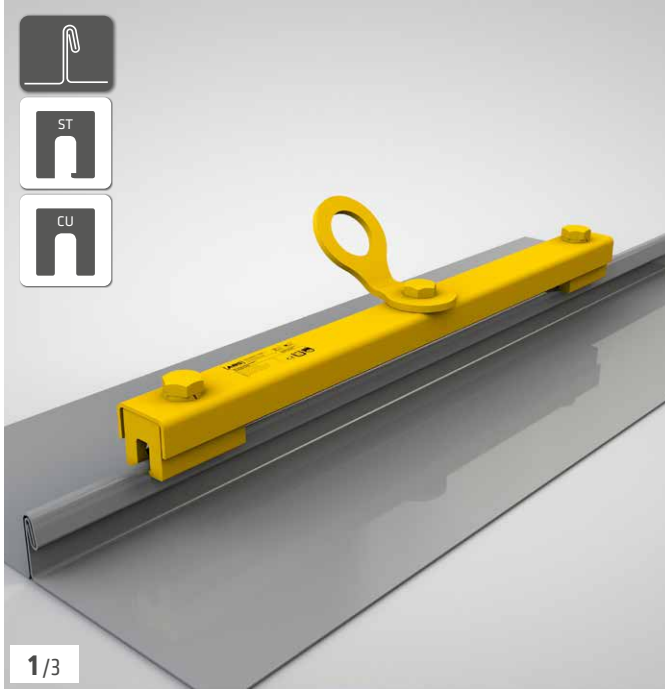



3 / 3



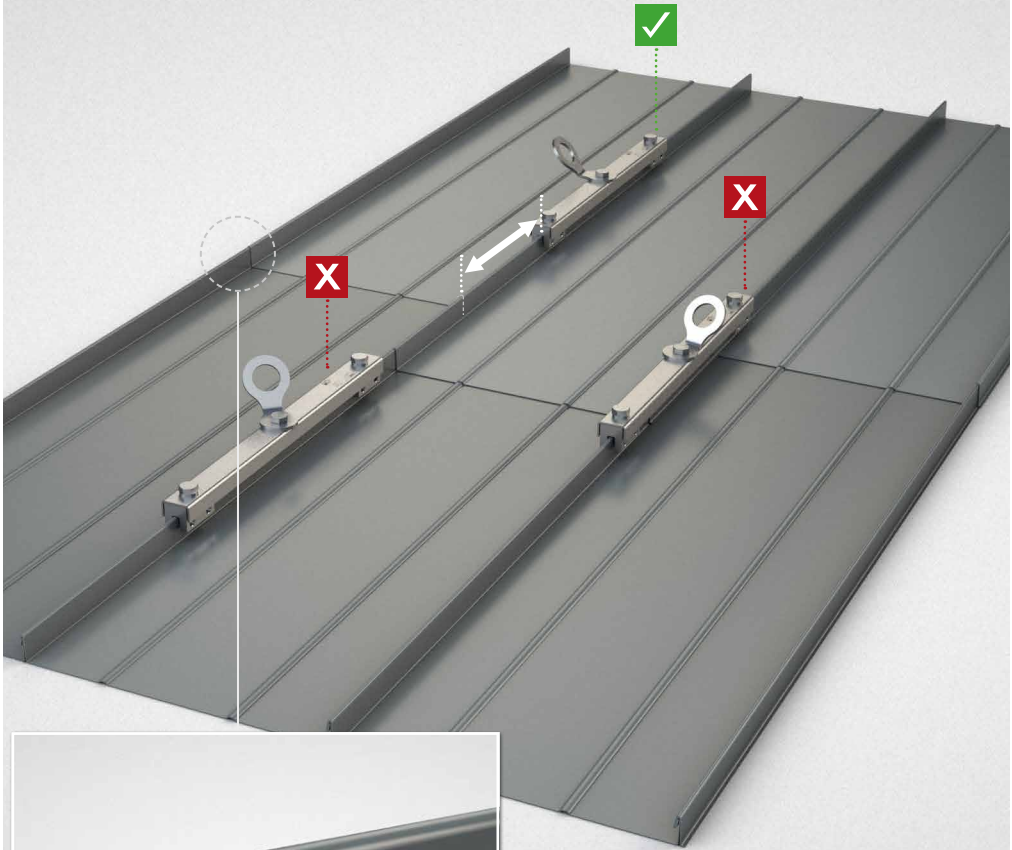

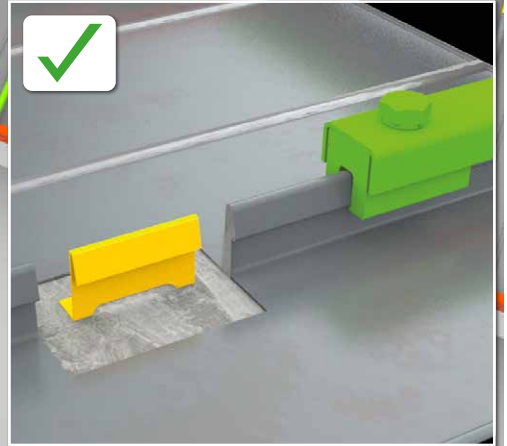
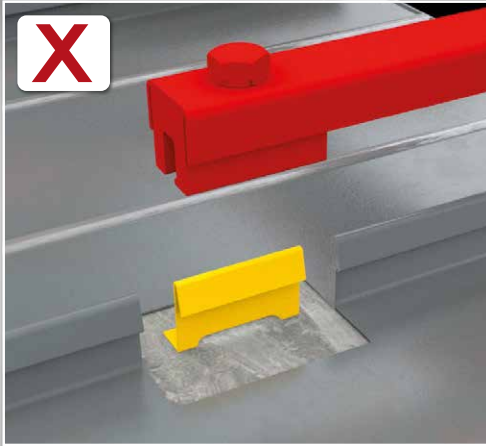
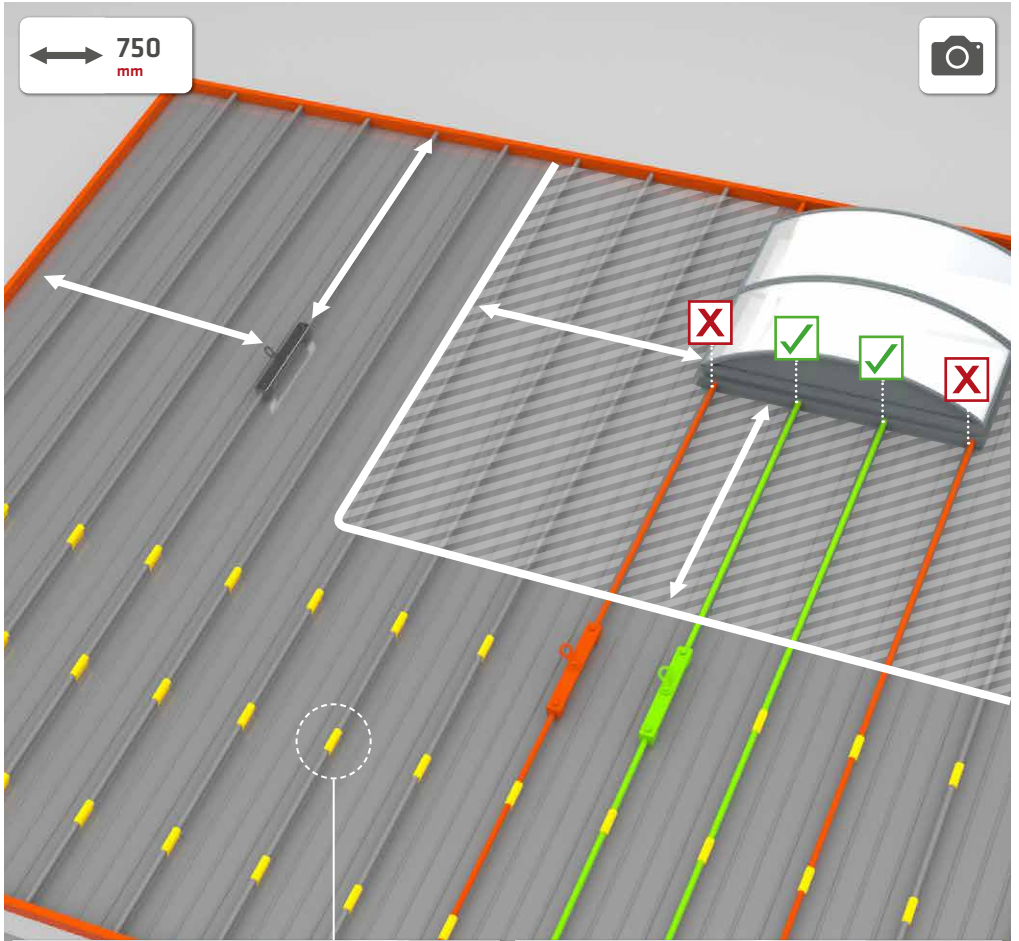

ALWAYS ON TOP!

ABS Safety GmbH

Gewerbering 3
D-47623 Kevelaer
Germany

Tel.: +49 28 32 972 81 - 0

Fax: +49 28 32 972 81 - 285

info@absturzsicherung.de

 www.absturzsicherung.de

 .de/en

 .de/fr

 .de/nl



[instagram.com/abssafety](https://www.instagram.com/abssafety)



[youtube.com/abssafetygmbh](https://www.youtube.com/abssafetygmbh)



[facebook.com/ABS.Safety](https://www.facebook.com/ABS.Safety)



[linkedin.com/company/abs-safety-gmbh](https://www.linkedin.com/company/abs-safety-gmbh)



[xing.com/pages/abssafetygmbh](https://www.xing.com/pages/abssafetygmbh)